

## Designated client product

This product will be discontinued its production in the near term.  
And it is provided for customers currently in use only, with a time limit.  
It can not be available for your new project. Please select other new or existing products.

For more information, please contact our sales office in your region.

New Japan Radio Co.,Ltd.

[www.njr.com](http://www.njr.com)

**SKY** **TECH**  
ELECTRONIC

STEREO MODULATOR

■ GENERAL DESCRIPTION

The NJM2035 is an integrated circuit used to generate a stereo composite signal and obtain switching output and 19kHz pilot signal due to two input audio signal and 38kHz X-tal and a few external CR.

The NJM2035 operates at 1.5V battery typically and even at 1.2V obtains separation more than 25dB.

NJM2035 can generate stereo multiplex signal easily by combination battery generator section.

■ PACKAGE OUTLINE

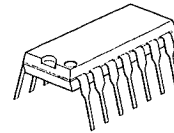

NJM2035D

■ FEATURES

- Low Operating Voltage ( $V^+ \geq 1.0V$ )
- Low Operating Current ( $I_{cc} \leq 3.0mA$ )
- High Separation ( $SEP \geq 25dB$ )
- Separation Adjustable
- Package Outline DIP14, DMP14
- Bipolar Technology

■ BLOCK DIAGRAM

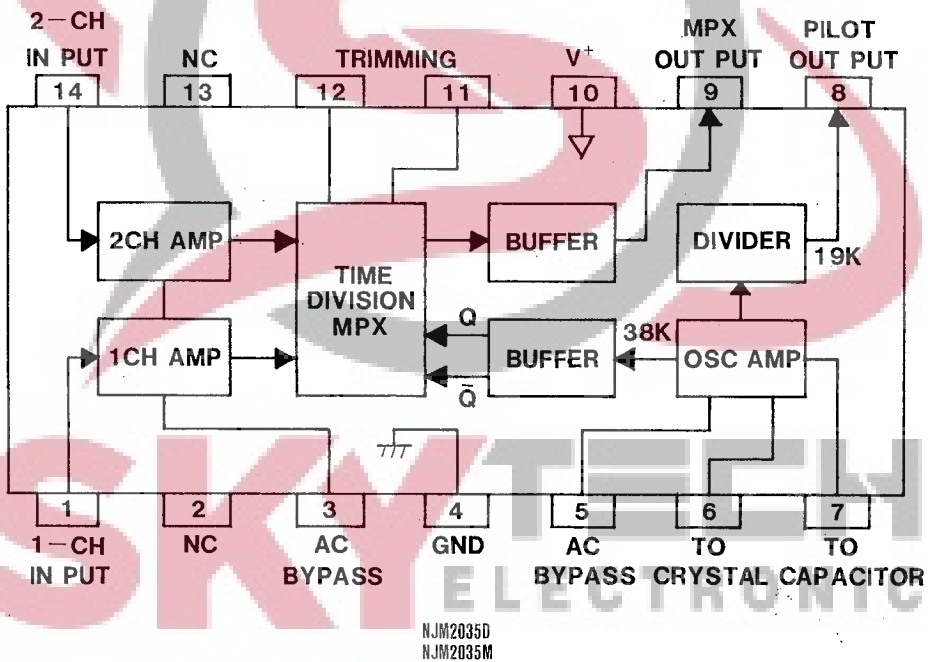

5

■ ABSOLUTE MAXIMUM RATINGS

(Ta=25°C)

PARAMETER	SYMBOL	RATINGS	UNIT
Supply Voltage	V*	3.6	V
Power Dissipation	P <sub>D</sub>	(DIP14) 500 (DMP14) 300	mW
Operating Temperature Range	T <sub>opr</sub>	-20~+75	°C
Storage Temperature Range	T <sub>stg</sub>	-40~+125	°C

■ ELECTRICAL CHARACTERISTICS

(Ta=25°C, V\*=1.5V)

PARAMETER	SYMBOL	TEST CONDITION	MIN.	TYP.	MAX.	UNIT
Operating Current	I <sub>cc</sub>	R <sub>L</sub> = ∞	—	1.8	3.0	mA
Input Impedance	Z <sub>IN</sub>	f=1kHz	—	420	—	Ω
Maximum Input Current	I <sub>IM</sub>		—	4.1	—	μA
Voltage Gain	G <sub>V</sub>	R <sub>S</sub> = 2kΩ, R <sub>L</sub> = 10kΩ	16	20	—	dB
Difference Gain Between Channels	G <sub>VD</sub>	R <sub>S</sub> = 2kΩ, R <sub>L</sub> = 10kΩ	—	—	2.0	dB
Equivalent Input Noise Voltage	V <sub>NI</sub>	R <sub>S</sub> = 2kΩ, R <sub>L</sub> = 10kΩ, A <sub>WEIGHTED</sub>	—	—	2.0	μVrms
Maximum Output Voltage Swing	V <sub>OM</sub>	R <sub>S</sub> = 2kΩ, R <sub>L</sub> = 10kΩ	140	200	—	mVp-p
Output Impedance	Z <sub>O</sub>	f=1kHz	—	230	—	Ω
Pilot Output Voltage	V <sub>OP</sub>	R <sub>L</sub> = 150kΩ	—	240	—	mV
Pilot Output Impedance	R <sub>OP</sub>		—	3	—	kΩ
Separation	SEP	f=1kHz at Application Circuit	—	40	—	dB
Internal Separation Compensation	S.C		—	-19	—	dB

**SKY**TECH  
ELECTRONIC

## ■ TYPICAL CHARACTERISTICS (\*: BY APPLICATION CIRCUIT)

### Operating Current vs. Operating Voltage

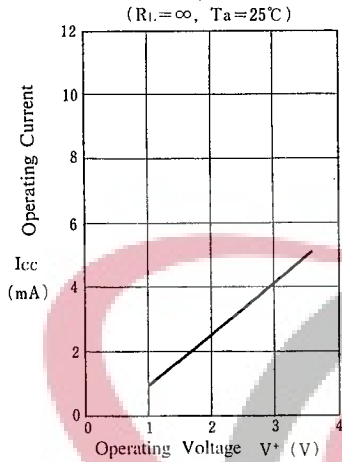

### Voltage Gain vs. Input Series Resistance

( $f = 1\text{kHz}$ ,  $R_L = 10\text{k}\Omega$ ,  $T_a = 25^\circ\text{C}$ )

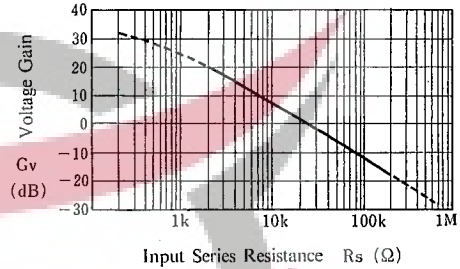

### Pilot Output Voltage vs. Operating Voltage

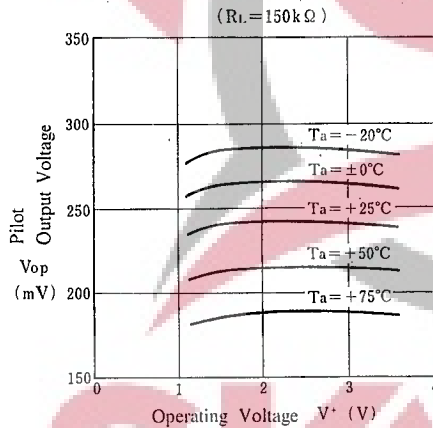

### ※ Separation vs. Frequency

( $V_{IN} = 150\text{mV}$ ,  $T_a = 25^\circ\text{C}$ )

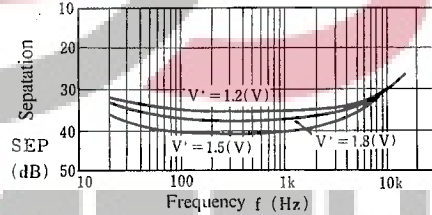

### ※ Total Harmonic Distortion vs. Modulation

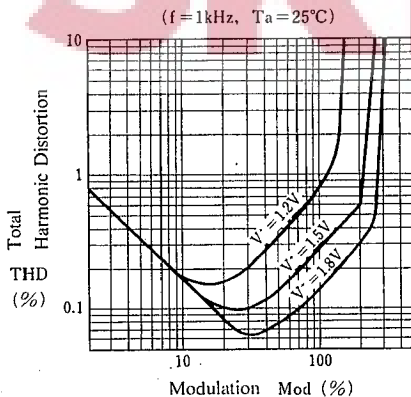

### MPX Maximum Output Voltage Swing vs. Operating Voltage

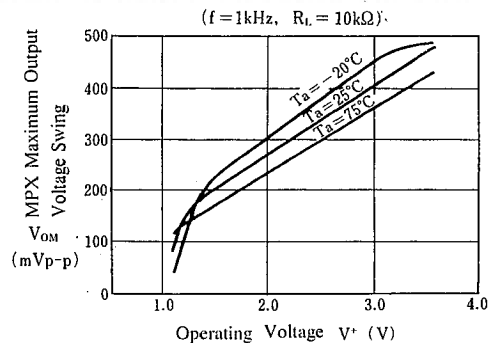

■ APPLICATION CIRCUIT EXAMPLES

The following block diagram shows an FM stereo transmitter using NJM2035. Input a current mode signal, because two inputs of NJM2035 are of a low impedance type. Also, the pre-emphasis can be applied at a time constant of  $C_L$  and  $R_L$  by utilizing this characteristic.

Input series resistance  $R_s$  of low band can be obtained from the maximum input voltage  $V_{IM(P-P)}$  and the maximum input current  $I_{IM}$  of NJM2035.

$$R_s = V_{IM} / 2I_{IM} \quad (R_s = R_1 + R_2)$$

However, the circuit for stabilized operation,  $R_2$  must stay between 2~12k $\Omega$ , and also, in order to get enough pre-emphasis characteristics,  $R_1$  is required to maintain within the range of  $5 \times R_2 \sim 10 \times R_2$ . Transmitting on FM stereo, it is advisable to set the pre-emphasis time  $C_1$ ,  $R_1$  at 50 $\mu$ s. When it is large maximum input voltage and could not satisfy  $R_1$ ,  $R_2$  condition, it is important to attenuate the input voltage beforehand, like that of Fig.2 the circuit example. In this case however, special care must be taken for not making the pre-emphasis time control influenced from the attenuator.

In order to get the important composit signals for stereo transmitting, the MPX signal and the pilot signal which were delivered output at each different pins, to be mixed (MIX) and the ratio is decided by the modulation of NJM2035 the maximum output voltage  $V_{OM}$  that means that, it can be decided by how much percent to be set the ratio of the maximum modulation. The maximum modulation takes the essential part to decide the dynamic range and to be set with consideration of modulation sensitivity of FM transmitter, S/N and also with the linearity of receiver. In general, 200% modulation ( $\Delta f = \pm 150\text{MHz}$ ) will give the satisfying result.

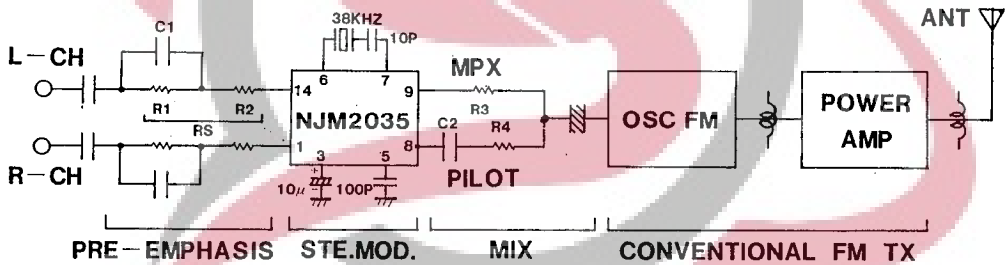

Fig1



5

## RECOMMENDED APPLICATION CIRCUIT & EACH WAVEFORM

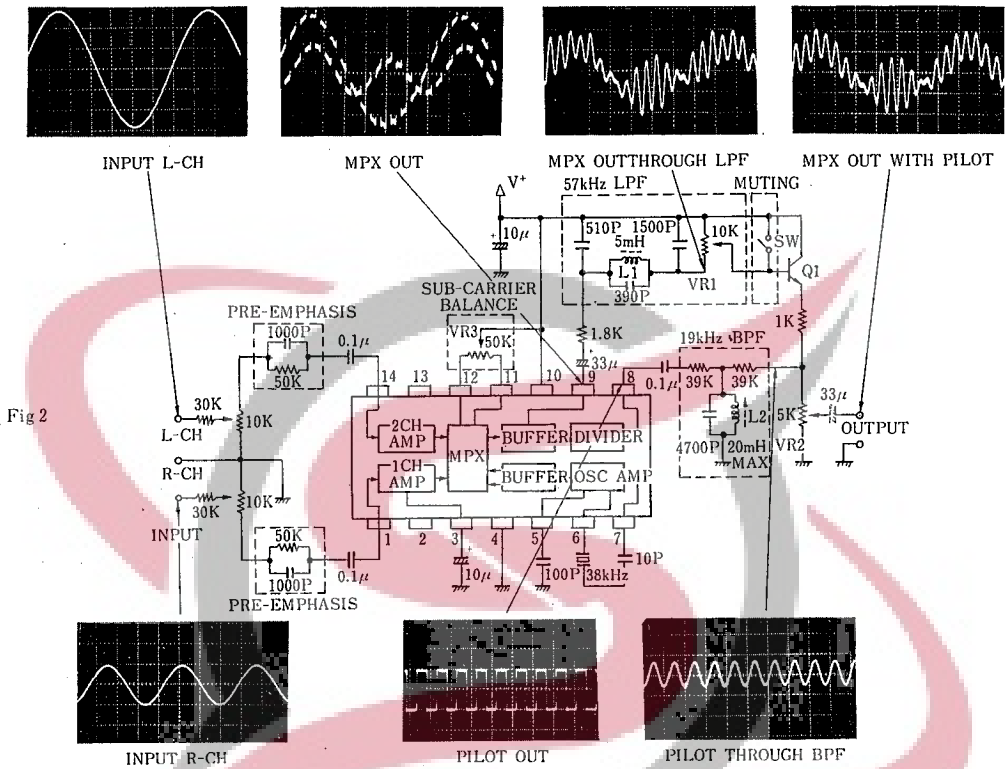

Fig 2

### The adjustment procedure in the recommended application circuit.

- ① Sub-carrier leakage can be minimized by the adjustment of VR<sub>3</sub>.
  - ② The maximum output voltage of pilot can be obtained by the adjustment of L<sub>2</sub>.
  - ③ VR<sub>2</sub> adjustment of the pilot will help to bring the modulation ratio a little over 10% ( $\Delta f = \pm 7.5\text{kHz}$ )
  - ④ The modulation ratio can be increased as much as 30% at VR<sub>1</sub> by putting designed standard input.
  - ⑤ By putting only the input for L-channel, and making re-adjustment of L<sub>2</sub>, so that the maximum power of output at L-channel can be obtained at the receiver's side. (19kHz phase adjustment)
- Against 100% modulation at the recommended circuit S/N at A curve +15kHz LPF 77dB, and at 15kHz LPF 67dB approximately can be obtained.

Recommended Application Circuit & Each Waveform on the other hand, the pilot level is to be modulated 10% with no connection of Max. modulation ratio, so that the following relation can be set.

$$\frac{R_0 + R_3}{R_0 + R_4} \times \frac{2\sqrt{2} V_{OP}}{V_{OM}} = \frac{10}{200}$$

However, for the stability in operation, it is advisable to control MPX signal loading more than 1.8k $\Omega$ , and the pilot signal loading more than 39k $\Omega$ .

As in example of Fig.1 Simplified Application Circuit, when making the rectangular wave like output to be the composite signal itself, the separating effect shall be reduced due to influence by harmonic components included in MPX signal, so that it requires to make the adjustment to be able to get ample separation of pilot signal phase by the operation of C<sub>2</sub>, R<sub>4</sub>, time signal. In this procedure, there is defective side of getting slightly difference of the best position of separating effect depending upon the tuner of receiver's side, however, when R<sub>3</sub> = 2k $\Omega$ , R<sub>4</sub> = 150k $\Omega$ , C<sub>2</sub> = 330pF then the ample separation can be obtained practically.

Special care must be taken that the pilot signal's the third harmonic wave 57kHz will be the cause of dangerous beating.

Fig 2 indicates the example of recommended application circuit of stereo modulation when NJM2035 is used. As explained in the wave form, high quality composite signal can be obtained by only putting a simple filter beforehand. Then the previously mentioned problems can be improved a great deal.

The input in modulated 30% at AUX level (150mV) — changeable of + 3dB —  $\infty$  by volume control.

VR<sub>1</sub> corresponds to the fluctuation of GV feature of NJM2035, and also for fluctuation of modulation sensitivity of FM modulation circuit which is connected after VR<sub>2</sub>.

VR<sub>3</sub> is to make minimum adjustment of 38kHz sub-carrier leakage, and with this adjustment, it can control until about -50dB in comparing to 100% modulation level.

## MEMO



**[CAUTION]**

The specifications on this databook are only given for information, without any guarantee as regards either mistakes or omissions. The application circuits in this databook are described only to show representative usages of the product and not intended for the guarantee or permission of any right including the industrial rights.

# Mouser Electronics

Authorized Distributor

Click to View Pricing, Inventory, Delivery & Lifecycle Information:

[NJR:](#)

[NJM2035M](#) [NJM2035D](#)

